



EXPLORER PreXion3D

Make IT Visible –

Advanced Diagnostic Technologies
Moving You Forward

Make IT Visible – Overcoming Challenges at Every Step

Few companies on the market are as specialized in three-dimensional X-ray diagnostics as PreXion. With more than 15 years of experience in software-supported 3D X-ray imaging, PreXion systems offer outstanding precision for safe diagnostics and planning in all areas of dentistry. After an extremely successful entry into the US market, PreXion is proud to announce its new CBCT system: the PreXion3D EXPLORER PRO.

The PreXion3D EXPLORER is suited for a multitude of specialties:

• Implants • Oral Surgery • Periodontics • Endodontics • Orthodontics • TMJ • ENT • Airway Analysis • And More

Let PreXion empower you and your practice with in-person training, service and maintenance, while you achieve peace of mind with a full-service extended warranty that covers the entire device, x-ray tube head and the flat panel detector included.

Company Profile Imaging Technology Moving You Forward

PreXion Corporation is a Japanese company specializing in medical imaging research and development. Since our company was founded in 2007 as a spin-off from TeraRecon, Inc. we have been developing and distributing Dental Cone Beam CTs in the US and abroad. With our advanced accumulated imaging technologies, we succeeded in developing the world's first photoacoustic imaging system using NIR-LED as a light source. We are committed to continuously developing new technologies to contribute to human health throughout the world. We accomplish this through our company philosophy of "Make IT Visible" coupled with our entrepreneurial spirit.

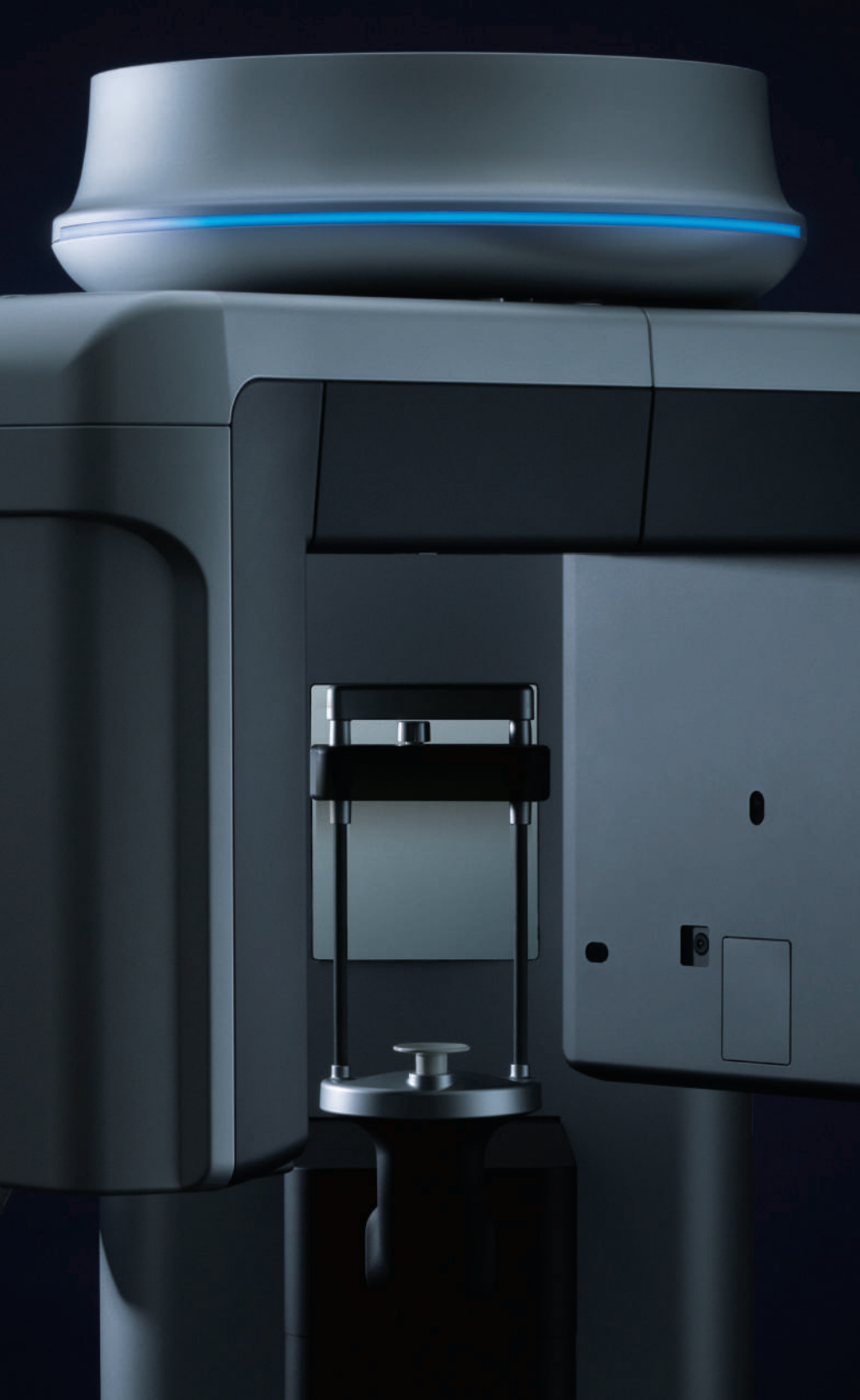

Why CBCT?

Why 3D instead of 2D?

Three-dimensional CBCT imaging is decisively superior to conventional two-dimensional X-ray equipment, as the dental professional can spatially examine the oral conditions according to the most varied medical aspects. 3D imaging can also reduce the length of time that patients are exposed to radiation. Additionally, the volume structure of the hard and soft tissues are incomparably better represented in 3D CBCT imaging than in 2D X-rays.

Why a large FOV?

With one of the largest fields of view (FOV) on the market (15 x 16cm), the PreXion3D EXPLORER can display all the important anatomical structures of the skull in great detail. The powerful imaging software helps to highlight and measure relevant areas. Large-area spatial image analysis helps to develop the best therapy options, particularly in oral and maxillofacial surgery, as well as ear, nose and throat medicine.

Why PreXion3D EXPLORER?

The powerful system components of the PreXion3D EXPLORER enable an extraordinary combination of the most precise 3D imaging, large image detail, lowest radiation exposure, reliable diagnostics and digital planning for all indications in modern dentistry, including periodontology, endodontics, implantology, orthodontics and maxillofacial surgery, among many others. Its patient management system is designed for secure and networked communication of patient data across multiple rooms within a practice and can be integrated into the existing infrastructure with ease.

With the precision and professional competence of PreXion, dental professionals have a powerful partner at their side.

Two Models for Every Clinical Need

EXPLORER PRO

(3-in-1)

- Three-dimensional CBCT
- 360° image capture
- World's smallest ceph footprint

- The first model of its kind with integrated ceph, saving practices up to three feet of space

EXPLORER EX

(2-in-1)

- Three-dimensional CBCT
- 360° image capture

EXPLORER PRO Ceph Arm

Utilizing the large flat panel, the EXPLORER PRO delivers a space-saving solution through PreXion's development of the world's first gantry-integrated cephalometric x-ray. In just 30 seconds, the gantry automatically shifts 45 degrees and opens by 6 inches to enable the capture of a ceph radiograph.



High Resolution; Low Radiation

With many 3D imaging systems on the market today, high-quality images are often accompanied by high radiation exposure. The PreXion 3D EXPLORER offers a favorable balance between both aspects. Its 0.3mm focal spot, 0.07mm voxel size and new features like a flat panel detector (FPD) provide the highest quality diagnostic images for clinicians with low radiation exposure for patients. The new FPD delivers extreme clarity by utilizing 2,048 x 2,560 pixels with an active area of 31.7 x 25.4cm - capable of capturing the entire cephalometric field.

Low Radiation Exposure Example:

FOV	Patient Size	Voxel Size	μSv (Exposure)*
5x5cm	Med Adult	0.07mm	11
10x10cm	Med Adult	0.1mm	41
15x10cm	Med Adult	0.2mm	58
15x16cm	Med Adult	0.2mm	85

*Exposure in EXPLORER PRO Low Dose Mode

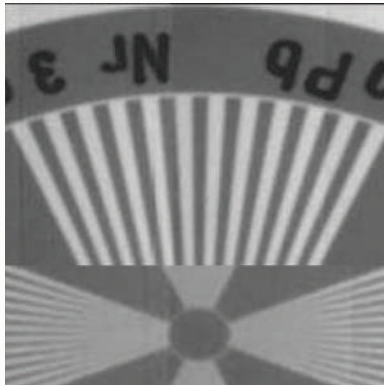

0.3mm Focal Spot
(PreXion)

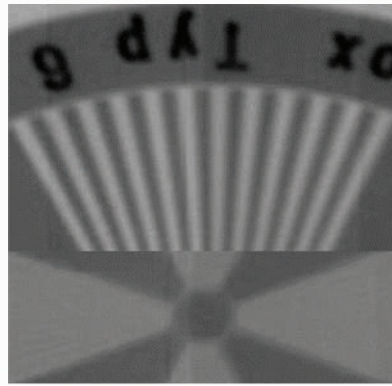

0.5mm Focal Spot
(Most Competitors)

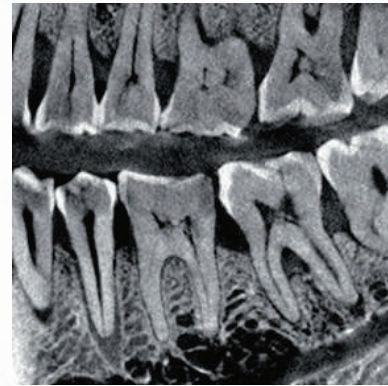

5x5cm FOV
0.07mm Voxel Size

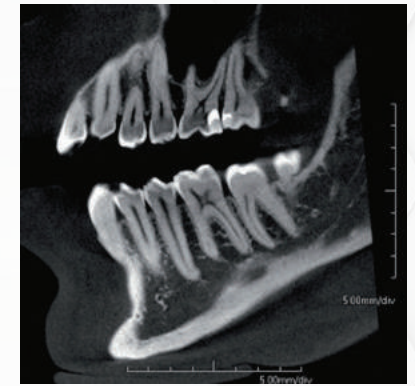

10x10cm FOV
0.1mm Voxel Size

What is a focal spot?

The focal spot, also called focus, is the area on the target of the X-ray tube which is struck by the electron stream and emits X-rays. The larger the focal spot's area, the poorer the detail of the image. The PreXion3D EXPLORER has a 0.3mm focal spot – one of the smallest in the industry.

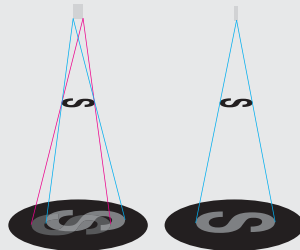

What is a voxel?

A combination of the words "volumetric" and "pixel," a voxel is a three-dimensional volume element shaped like an isometric cube. The EXPLORER utilizes one of the smallest size focal spots in the industry at 0.3mm for all FOVs, and voxel sizes ranging from 0.07 to 0.3mm in order to maintain image quality.

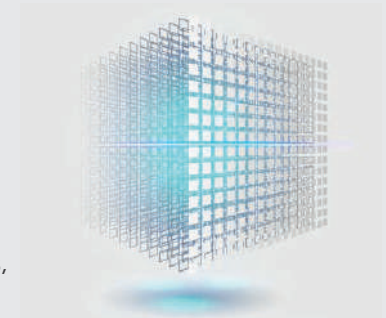

© Yuri Hoyda | D stock.adobe.com

The EXPLORER utilizes one of the smallest focal spots in the industry at 0.3mm for all FOVs, and voxel sizes ranging from 0.07 to 0.3mm in order to maintain image quality. The output in ultra-HD with a small voxel size enables a more detailed representation.

Fields of View

The PreXion3D EXPLORER provides an accurate 360° panoramic perspective from 523 to 1,024 projected views. In addition to the 3D analysis function for image detail sizes of 5x5cm, 10x10cm, 15x10cm, and 15x16cm, the device features “True” and “Reconstructed” panorama modes. It impresses with its ease of operation, comprehensive planning programs and imaging software across all dental indication areas.

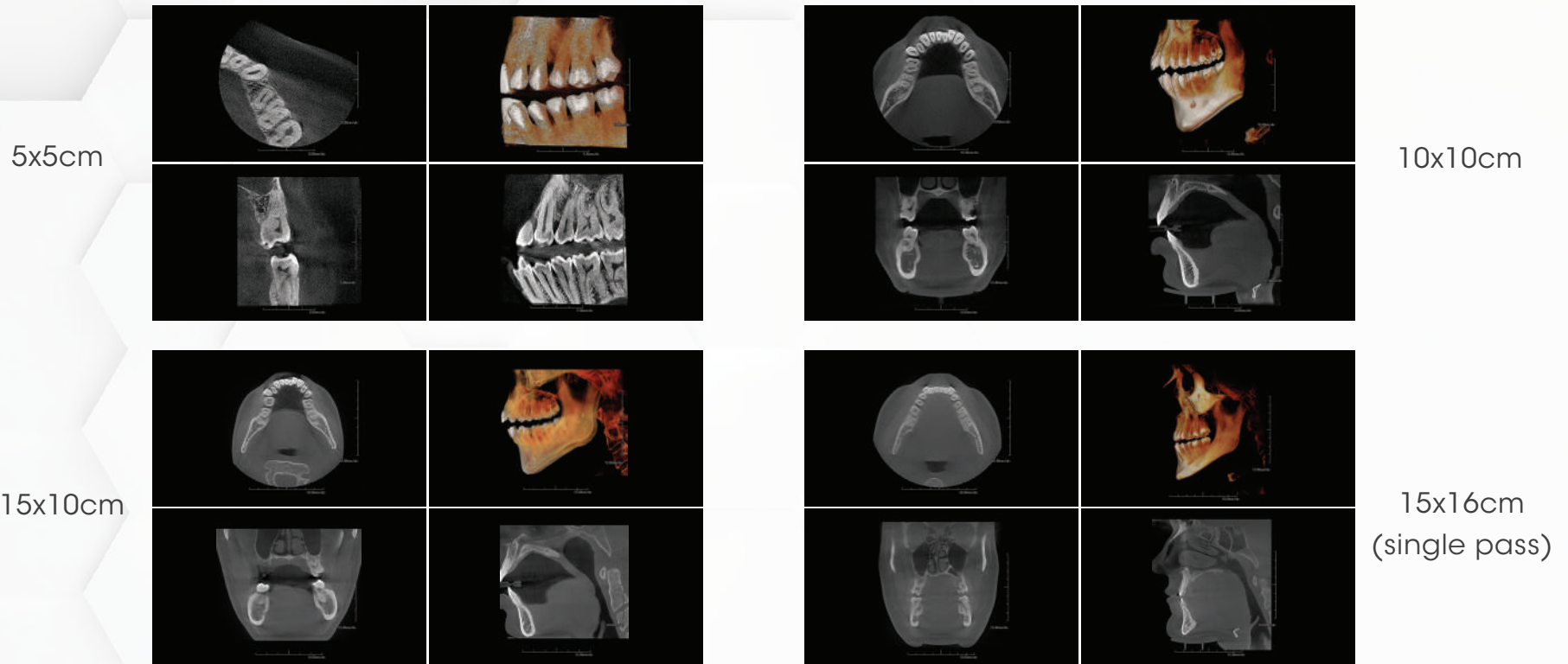

Voxel size range for each FOV:

5x5cm: 0.07-0.1mm	10x10cm: 0.1-0.2mm	15x10cm: 0.2-0.3mm	15x16cm: 0.2-0.3mm
-------------------	--------------------	--------------------	--------------------

An X-ray cone beam irradiates around the object. The acquired data is used to generate and display a 3D image. The size of the cone beam can be selected based on the scanned area (Face/Full/Teeth), as well as the size of the patient.

Fields of Application

The precise and high-resolution display of hard and soft tissue enables outstanding diagnostics and planning across all areas of modern dentistry and maxillofacial surgery.

Endodontics

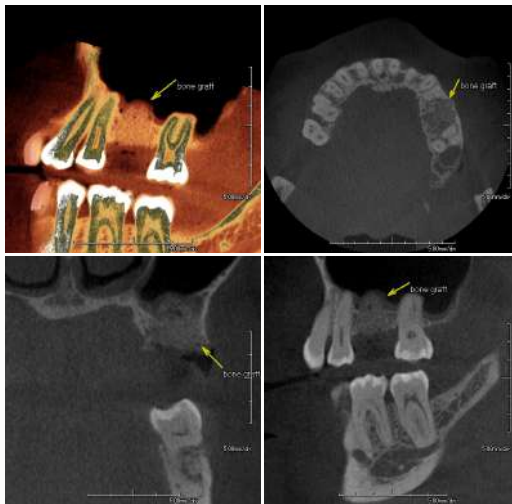

Implantology

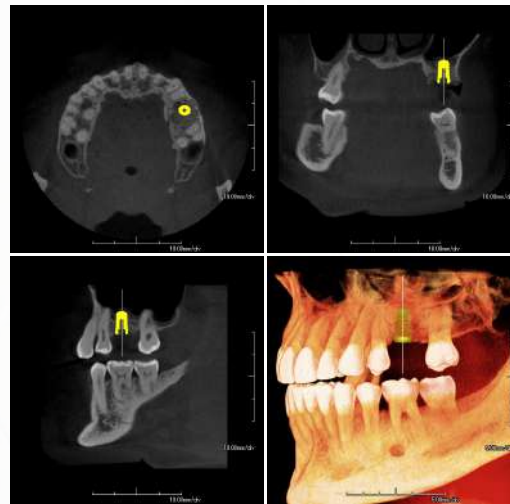

Airway Analysis

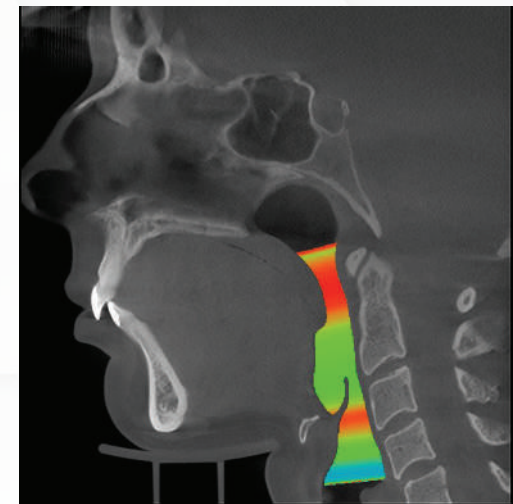

Bitewing

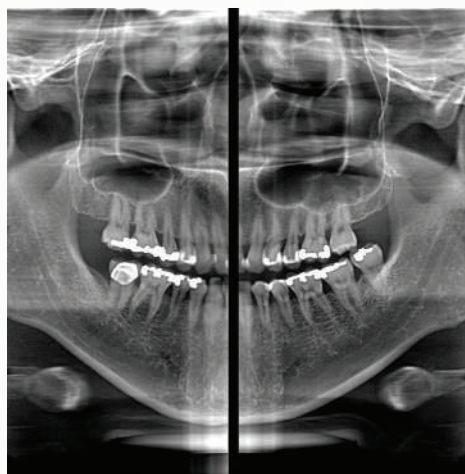

Panoramic

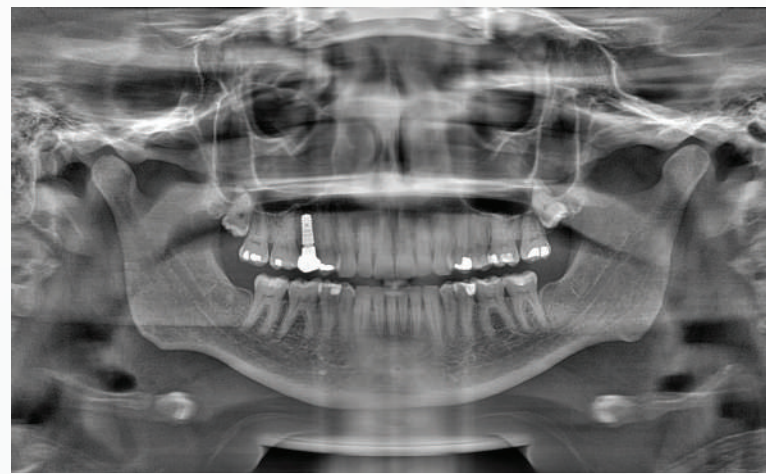

Orthodontics (PRO model only)



Make IT Visible – The Power of PreXion’s Service



Improving image quality with exclusive innovative technologies.

PreXion is committed to excellence in service and support. A true industry leader understands that reputations are earned one customer at a time. PreXion has repeatedly provided a uniquely exceptional experience in the market for over 15 years with an uncompromising dedication to product reliability, service and support. From cutting-edge technology, industry-leading response times and an expansive KOL support network, PreXion takes pride in delivering complete customer satisfaction.

PreXion 5-Star Service Guarantee

1. Both online and in-office service and training performed by PreXion company technicians.
2. Periodic software upgrades to meet expanding clinical offerings and demands.
3. Continuing learning opportunities via educational courses and seminars.
4. Fast, reliable support call center to minimize disruption and maximize user satisfaction.
5. Industry’s best warranty, featuring comprehensive coverage of the machine, including the x-ray tube head and the flat panel detector.



Lou Graham DDS FAGD, USA

“Over 5 years ago, I bought my second CBCT and it was a PreXion. Over these past 5 years, the training and service have been second to none and if you’re investing in such a piece of equipment, it is essential both of these criteria be 100%. Add the great images and easy software interface, my entire multi-specialty users just love our unit. This company walks the walk for its clients and continues to set the bar for anyone interested in purchasing a CBCT.”

EXPLORER PRO

CT Mode:

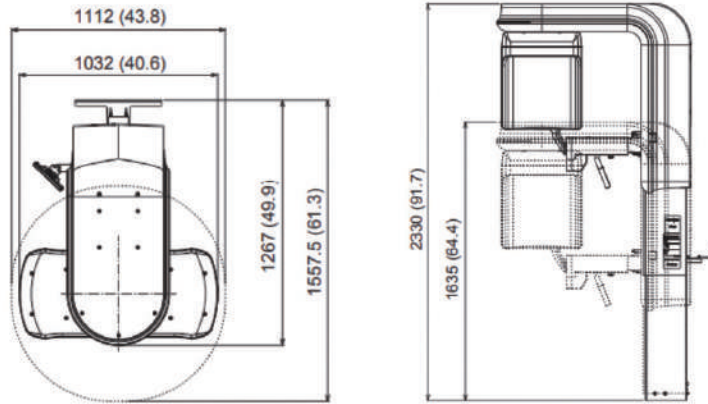

Cephalometric Mode:

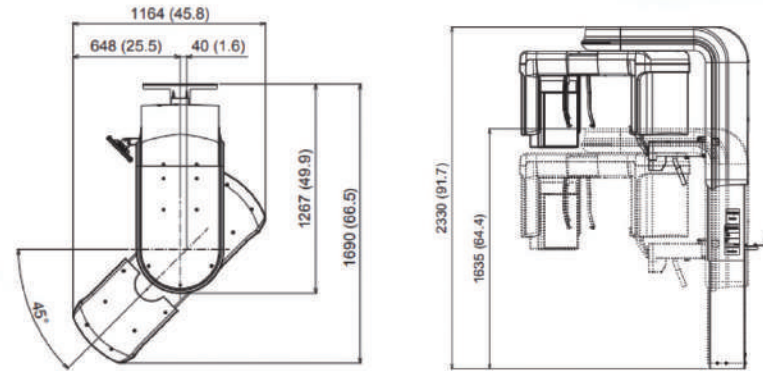

Unit of length: mm (inches)

Floor fixation and wall fixation are necessary for this device.

Device Type		Required Specifications	
Cone Beam Computed Tomography System, Head/Neck			
Focal Spot	0.3mm x 0.3mm	For Console (PreXion-provided)	Intel Xeon Processor (3.2 GHz or Faster 4 Core Turbo HT) Video Card with at Least 5 GB of Onboard Video Memory TrueColor 24bit RGB Display Monitor Resolution: 1,920 x 1,080 or higher Main Memory of at Least 32 GB 1 Gbit NIC Add-in Card x 2 (Jumbo Frame) Microsoft Windows 10 (64bit) Pro Edition Hard Drive: 3 (256GB, 2TB x2) Monitor Size: 19inch or larger The PC Complies with IEC60950/CISPR22/EN55024
Tube Voltage	90-110kV		
Tube Current	1-5.3mA		
Total Filtration	2.7mm Al		
Voxel Size	0.07mm, 0.1mm, 0.2mm, 0.3mm		
FOV	Teeth: 5 x 5cm Arch: 10 x 10cm Full: 15 x 10cm Face: 15 x 16cm		
Scan Time	CT Scan Mode Low Dose Mode: 10 sec High-Definition Mode: 18 sec Endo Mode: 20 sec Panoramic Scan Mode Standard Mode: 14 sec Cephalometric Exposure Mode LA: 0.16 sec PA: 0.16 sec Carpus: 0.16 sec	For Network Client	Intel Pentium 4 Processor 1.5GHZ or Faster Video Card with at Least 128MB of Onboard Video Memory 16M Color (24bit RGB) Display Monitor Resolution 1,920 x 1,080 or higher Main Memory of at Least 1GB 1,000Mbit (1 Gbit Ethernet)/100 Mbit LAN Card or A 10 Mbit LAN Card is Recommended Microsoft Windows 10 Microsoft Word 2010, 2013 Must Be Installed When Using the Report Function Monitor Size: 19inch or Larger The PC Complies with IEC60950
Gray Scale	16 bit		
Patient Position	Standing/Wheelchair Accessible		
Scanner Weight	230kg (507lbs)		
Rated Power	Frequency: 50/60 Hz Voltage: 100-240V AC Input: 1.0kVA		

EXPLORER EX

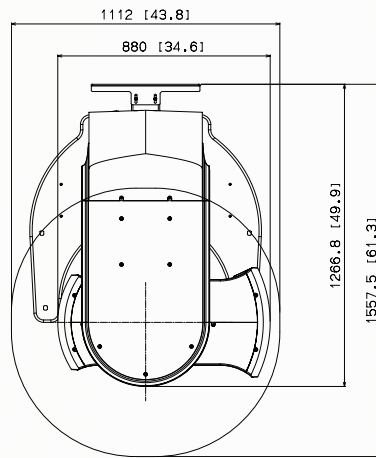

Unit of length: mm (inches)

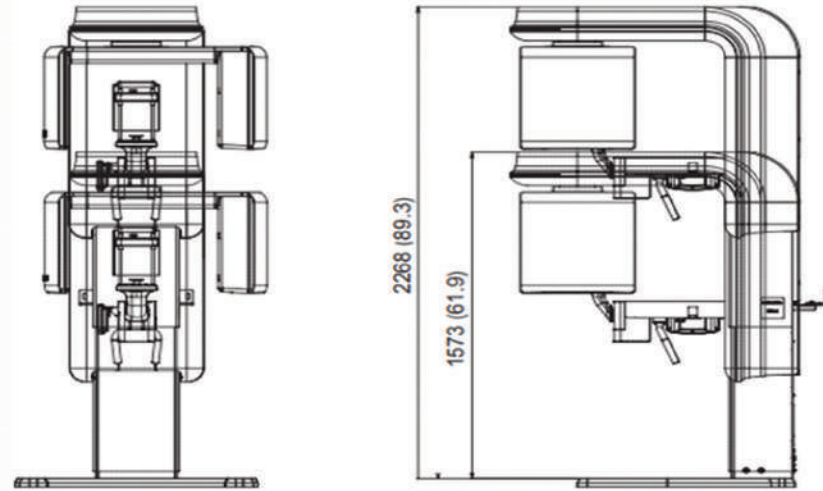

Floor fixation and wall fixation are necessary for this device.

Device Type	Cone Beam Computed Tomography System, Head/Neck	Required Specifications	
Product Name	PreXion3D EXPLORER EX		
Focal Spot	0.3mm x 0.3mm	For Console (PreXion-provided)	Intel Xeon Processor (3.2 GHz or Faster 4 Core Turbo HT) Video Card with At Least 5 GB of Onboard Video Memory TrueColor 24bit RGB Display Monitor Resolution: 1,920 x 1,080 or higher Main Memory of at Least 32 GB 1 Gbit NIC Add-in Card x 2 (Jumbo Frame) Microsoft Windows 10 (64bit) Pro Edition Hard Drive: 3 (256GB, 2TB x2) Monitor Size: 19inch or larger The PC Complies with IEC60950/CISPR22/EN55024
Tube Voltage	90-110kV		
Tube Current	1-5mA		
Total Filtration	2.7mm Al		
Voxel Size	0.07mm, 0.1mm, 0.2mm, 0.3mm		
FOV	Teeth: 5 x 5cm		
	Arch: 10 x 10cm		
	Full: 15 x 10cm		
	Face: 15 x 16cm		
Scan Time	CT Scan Mode	For Network Client	Intel Pentium 4 Processor 1.5GHZ or Faster Video Card with at Least 128MB of Onboard Video Memory 16M Color (24bit RGB) Display Monitor Resolution 1,920 x 1,080 or higher Main Memory of at Least 1GB 1,000Mbit (1 Gbit Ethernet)/100 Mbit LAN Card or A 10 Mbit LAN Card is Recommended Microsoft Windows 7 or 10 Microsoft Word 2010, 2013 Must Be Installed When Using the Report Function Monitor Size: 19inch or Larger The PC Complies with IEC60950
	Standard Mode: 10 sec		
	High-Definition Mode: 18 sec		
	Ultra High-Definition Mode: 20 sec		
Panoramic Scan Mode	Standard Mode: 14 sec		
Gray Scale	16 bit		
Patient Position	Standing/Wheelchair Accessible		
Scanner Weight	198kg (436lbs)		
Rated Power	Frequency: 50/60 Hz Voltage: 100-240V AC Input: 1.0kVA		

Innovation Timeline



PreXion 3D Elite



PreXion 3D Eclipse



PreXion 3D Excelsior



PreXion 3D Explorer EX



PreXion 3D Explorer PRO

2007

2013

2017

2020

2021



[USA]

PreXion, Inc.

2077 Gateway Place, Suite 120, San Jose, CA 95110, USA

Tel: +1-650-212-0300 Fax: +1-650-212-0310

Email: info@prexion.com <http://www.prexion.com>

[JAPAN]

PreXion Corporation

1-14-1 Kanda Suda-cho, Chiyoda-ku, Tokyo, 101-0041, Japan

Tel: +81-3-5297-2822 Fax: +81-3-5297-7552

Email: info@prexion.co.jp <http://www.prexion.co.jp>

*Product specifications and functions may change without prior notice. PJ003/2105 EN1